



HMU-P/PF Undercut anchor

Product Technical Datasheet



Steel-to-concrete

Update: Feb 25









HMU-P/PF Undercut anchor

High-performance undercut anchor for cracked concrete

Anchor version	Benefits
 <p>HMU-P (M10-M12)</p>	<ul style="list-style-type: none"> - Reliable mechanical interlock due to consistent high quality self-undercut
 <p>HMU-PF (M10-M16)</p>	<ul style="list-style-type: none"> - ETA approval for cracked and uncracked concrete - Seismic approval ETA C1 and C2 - Comes standard with a hot-dip galvanized protective coating against corrosion (version PF)
	<ul style="list-style-type: none"> - Cost efficient heavy duty anchoring solution for high volume fastenings
	<ul style="list-style-type: none"> - Easy verification of correct setting due to red setting mark
	<ul style="list-style-type: none"> - Optimized and matching system components enable efficient and reliable installation

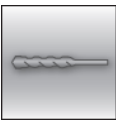

Base material	Load conditions
 <p>Concrete (uncracked)</p>  <p>Concrete (cracked)</p>	 <p>Static/ quasi-static</p>  <p>Seismic, C1, C2</p>  <p>Fire resistance</p>

Drilling, cleaning, setting	Other information
 <p>Hammer drilled holes</p>	 <p>PROFIS Engineering Software</p>  <p>Steel to concrete handbook</p>



Linked Approvals/Certificates and Instructions for use

Approvals/certificates





Approval no	Application / loading condition	Authority / Laboratory	Date of issue
ETA-14/0069	Static and quasi-static / Seismic / Fire	CSTB, Marne-la-Vallée	05-06-2020

The instructions for use can be viewed using the link in the instructions for use table or the QR code/link in the Hilti webpage table.

Instructions for use (IFU)

Anchor size	M10	M12	M16
HMU P/PF	IFU HMU M10-P/PF	IFU HMU M12-P/PF	IFU HMU M16-PF

Link to Hilti Webpage

HMU-P	HMU-PF	HMU-ST Setting tool	TE-C-HMU-B Stop drill bit
			

Fastener special dimensions

Letter code for anchor length

Anchor size-M10	HMU-P/PF M10x60/20	HMU-P/PF M10x60/50	-
Letter code	F	H	-
Anchor size-M12	HMU-P/PF M12x80/20	HMU-P/PF M12x80/35	HMU-PF M12x80/65
Letter code	H	I	K
Anchor size-M16	HMU-PF M16x100/30	HMU-PF M16x100/60 HMU-PF M16x125/30	HMU-PF M16x125/60
Letter code	K	M	O

Anchor dimension

Anchor size		M10x60	M12x80	M16x100	M16x125
Total length of bolt	min	109,5	133	167	222
	max				
Diameter of sleeve	d_s [mm]	14,5	17,5	21,6	21,6
Length of sleeve	l_s [mm]	61	80,6	100	125

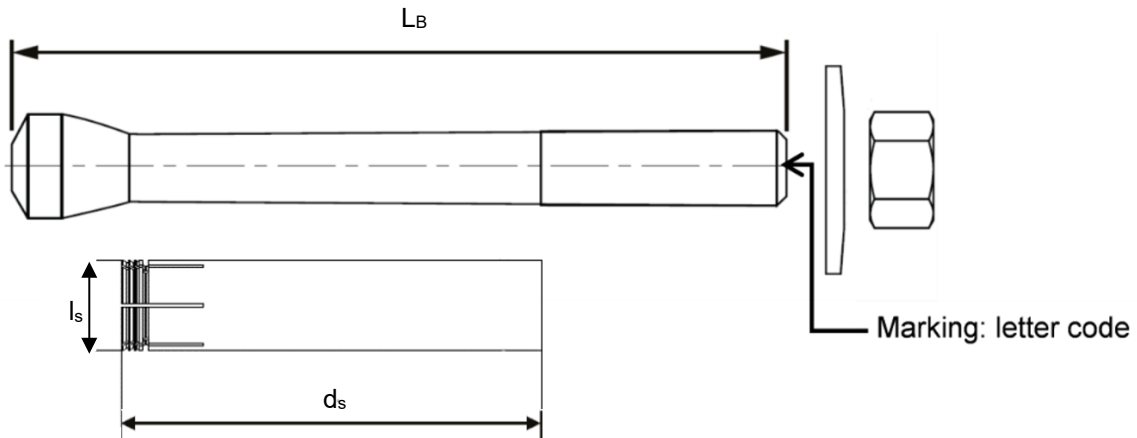



Static loading based on ETA-14/0069. Design according to EN 1992-4

All data in this section applies to:

- Correct setting (see setting instruction)
- For a single anchor
- Concrete C20/25
- Hammer drilled holes
- No edge distance and spacing influence (see setting detail tables with characteristic distances)
- Characteristic spacing and edge distance for splitting failure apply only for uncracked concrete
- For cracked concrete only the characteristic spacing and edge distance for concrete cone failure are decisive
- Minimum base material thickness (see setting detail table)
- Embedment depth, as specified in the table of this section
- Recommended loads: With overall partial safety factor for action $\gamma = 1,4$

For specific design cases refer to [PROFIS Engineering](#).

Design resistance

Anchor size			M10x60	M12x80	M16x100	M16x125	
Effective anchorage depth	h_{ef}	[mm]	60	80	100	125	
Uncracked concrete							
Tension	HMU-P/PF	N_{Rd}	[kN]	15,2	23,5	32,8	45,8
Shear	HMU-P/PF	V_{Rd}		18,6	27,0	50,2	50,2
Cracked concrete							
Tension	HMU-P/PF	N_{Rd}	[kN]	10,7	16,4	23,0	32,1
Shear	HMU-P/PF	V_{Rd}		18,6	27,0	45,9	50,2

Recommended loads

Anchor size			M10x60	M12x80	M16x100	M16x125	
Effective anchorage depth	h_{ef}	[mm]	60	80	100	125	
Uncracked concrete							
Tension	HMU-P/PF	N_{rec}	[kN]	10,9	16,8	23,4	32,7
Shear	HMU-P/PF	V_{rec}		13,3	19,3	35,9	35,9
Cracked concrete							
Tension	HMU-P/PF	N_{rec}	[kN]	7,6	11,7	16,4	22,9
Shear	HMU-P/PF	V_{rec}		13,3	19,3	32,8	35,9

Seismic loading based on ETA-14/0069. Design according to EN 1992-4

All data in this section applies to:

- Correct setting (see setting instruction)
- For a single anchor
- Concrete C20/25
- Hammer drilled holes
- No edge distance and spacing influence (see setting detail tables with characteristic distances)
- For cracked concrete only the characteristic spacing and edge distance for concrete cone failure are decisive
- Minimum base material thickness (see setting detail table)
- Embedment depth, as specified in the table of this section
- $\alpha_{\text{gap}} = 1,0$ (with using Hilti filling set) accordingly

For specific design cases refer to [PROFIS Engineering](#).

Design resistance in case of seismic category C2

Anchor size			M10x60	M12x80	M16x100	M16x125
Effective anchorage depth	h_{ef}	[mm]	60	80	100	125
Tension	HMU-PF	$N_{\text{Rd,seis}}$	9,1	14,0	-	27,3
Shear	HMU-PF	$V_{\text{Rd,seis}}$				
			14,8	22,9	-	33,2

Design resistance in case of seismic category C1

Anchor size			M10x60	M12x80	M16x100	M16x125
Effective anchorage depth	h_{ef}	[mm]	60	80	100	125
Tension	HMU-P/PF	$N_{\text{Rd,seis}}$	9,1	14,0	19,5	27,3
Shear	HMU-P/PF	$V_{\text{Rd,seis}}$				
			16,7	27,0	39,0	50,2



Fire loading based on ETA-14/0069. Design according to EN 1992-4

All data in this section applies to:

- Correct setting (see setting instruction)
- For a single anchor
- Cracked concrete C20/25
- Hammer drilled holes
- No edge distance and spacing influence (see setting detail tables with characteristic distances)
- Minimum base material thickness (see setting detail table)
- Embedment depth, as specified in the table of this section
- Partial safety factor for resistance under fire exposure $\gamma_{M,fi} = 1,0$

For specific design cases refer to [PROFIS Engineering](#).

Design resistance

Anchor size				M10x60	M12X80	M16X100	M16X125
Effective anchorage depth	h_{ef}	[mm]		60	80	100	125
Fire exposure R30							
Tension	HMU-P/PF	$N_{Rd,fi}$	[kN]	0,87	1,69	3,14	3,14
Shear	HMU-P/PF	$V_{Rd,fi}$		0,87	1,69	3,14	3,14
Fire exposure R60							
Tension	HMU-P/PF	$N_{Rd,fi}$	[kN]	0,75	1,26	2,36	2,36
Shear	HMU-P/PF	$V_{Rd,fi}$		0,75	1,26	2,36	2,36
Fire exposure R90							
Tension	HMU-P/PF	$N_{Rd,fi}$	[kN]	0,58	1,1	2,04	2,04
Shear	HMU-P/PF	$V_{Rd,fi}$		0,58	1,1	2,04	2,04
Fire exposure R120							
Tension	HMU-P/PF	$N_{Rd,fi}$	[kN]	0,46	0,84	1,57	1,57
Shear	HMU-P/PF	$V_{Rd,fi}$		0,46	0,84	1,57	1,57

Setting information

Setting details of HMU-PF/P

Anchor size			M10x60	M12x80	M16x100	M16x125
Effective anchorage depth	h_{ef}	[mm]	60	80	100	125
Nominal Diameter of drill bit ¹⁾	d_0	[mm]	15	18	23	
Diameter of clearance hole in the fixture	$d_{f,max}$	[mm]	12	14	18	
Thickness of fixture ²⁾	t_{fix}	min.	2	2	0	0
		max	50	65	60	75
Torque moment	T_{inst}	[Nm]	30	45	120	
Width across nut flats	SW	[mm]	17	19	24	
Minimum depth of drill hole	h_1		69	92	115	140
Minimum base material thickness	h_{min}	[mm]	120	160	200	250
Minimum distances						
Spacing	s_{min}	[mm]	60	90	100	100
Edge distance	c_{min}	[mm]	55	90	100	100
Characteristic distances ³⁾						
Spacing for splitting failure	$s_{cr,sp}$	[mm]	230	300	300	375
Edge distance for splitting failure	$c_{cr,sp}$	[mm]	115	150	160	200
Spacing for concrete cone failure	$s_{cr,N}$	[mm]	180	240	300	375
Edge distance for concrete cone failure	$c_{cr,N}$	[mm]	90	120	150	188

¹⁾ Use special stop drill bit TE-C-HMU-B and TE-Y-HMU-B only.

²⁾ When thickness of attachment is less than 3 mm, big washer acc. to DIN1052 standard needs to be used.

³⁾ In case of smaller edge distance and spacing than $c_{cr,sp}$, $s_{cr,sp}$, $c_{cr,N}$ and $s_{cr,N}$ the load values shall be reduced according EN 1992-4.

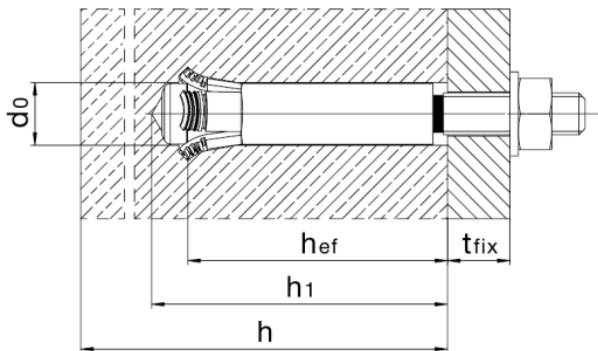

HMU-P/PF

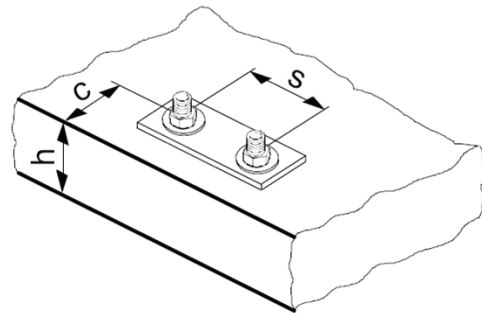



Drilling and Installation equipment

For detailed setting information on installation see instructions for use (IFU) given with the product.

Rotary Hammers (Corded and Cordless)		TE 2 - TE 50
Other tools		Torque tool(use recommended socket/driver bit/required attachment)
		Hammer drill -HMU stop drill bit
		Setting Tool
		Blow out pump